

VOLTAGE REGULATOR PLUS FILTER

- FIXED OUTPUT VOLTAGE 8.5 V
- 250 mA OUTPUT CURRENT
- HIGH RIPPLE REJECTION
- HIGH LOAD REGULATION
- HIGH LINE REGULATION
- SHORT CIRCUIT PROTECTION
- THERMAL SHUT DOWN WITH HYSTERESIS
- DUMP PROTECTION

DESCRIPTION

This circuit combines both a filter and a voltage regulator in order to provide a high ripple rejection over a wider input voltage range.

A supervisor low-pass loop of the element prevents the output transistor from saturation at low input voltages.

The non linear behaviour of this control circuitry allows a fast settling of the filter.

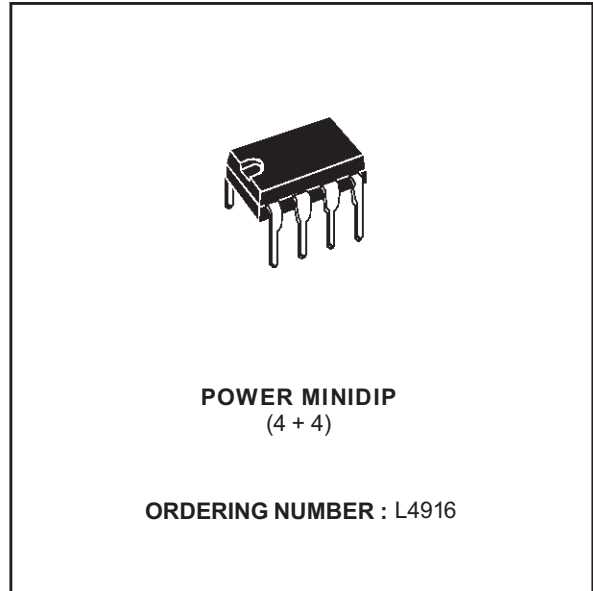

BLOCK DIAGRAM

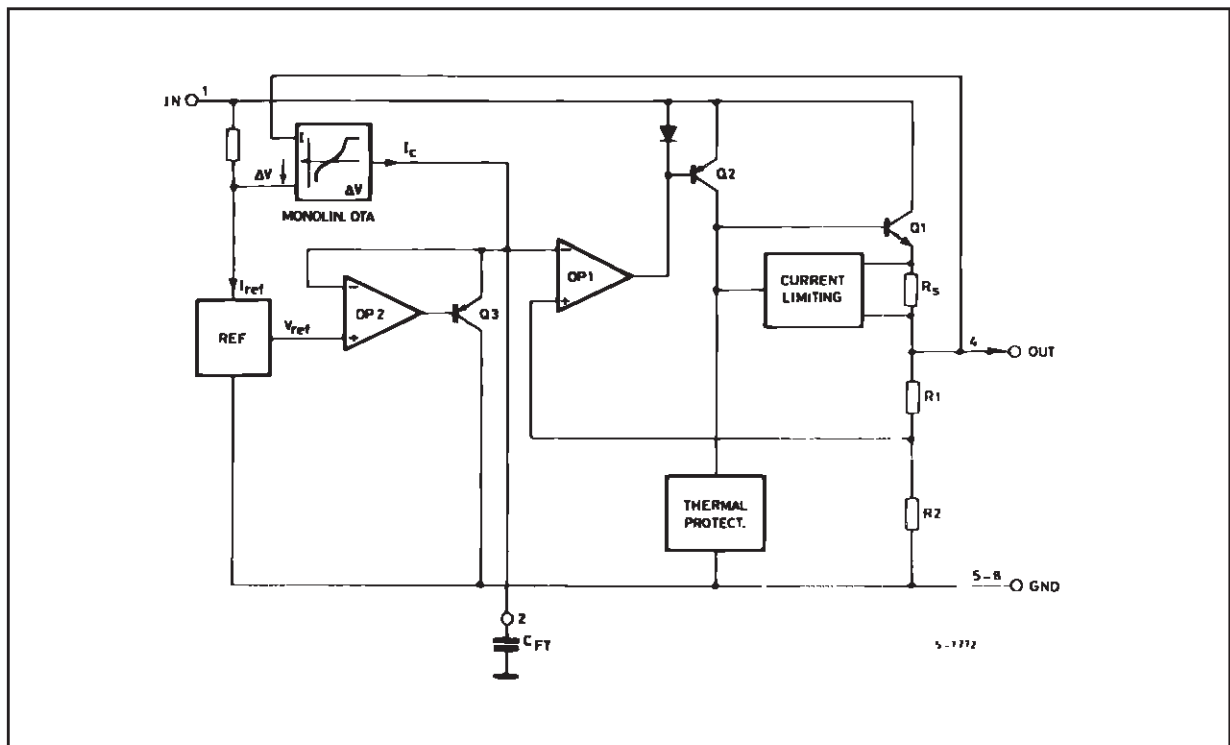

L4916

PIN CONNECTION (top view)

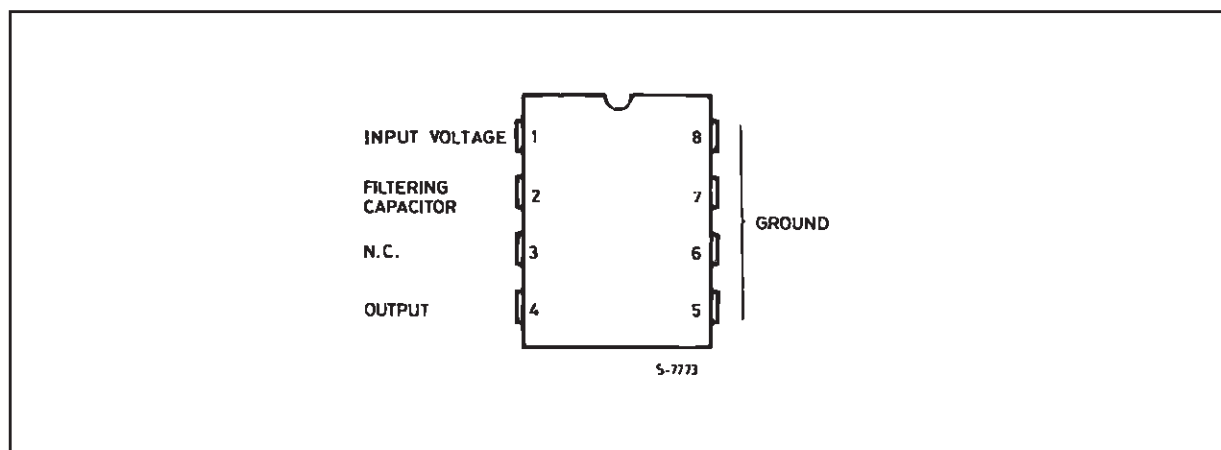

ABSOLUTE MAXIMUM RATINGS

Symbol	Parameter	Value	Unit
V_i	Peak Input Voltage (300 ms)	40	V
V_i	DC Input Voltage	28	V
I_O	Output Current	Internally Limited	
P_{tot}	Power Dissipation	Internally Limited	
T_{stg}, T_j	Storage and Junction Temperature	- 40 to 150	°C

THERMAL DATA

Symbol	Parameter	Value	Unit
$R_{th\ j-amb}$	Thermal Resistance Junction-ambient	80	°C/W
$R_{th\ j-pins}$	Thermal Resistance Junction-pins	20	°C/W

ELECTRICAL CHARACTERISTICS ($T_{amb} = 25\text{ }^{\circ}\text{C}$; $V_i = 13.5\text{ V}$, test circuit of fig. 1, unless otherwise specified)

Symbol	Parameter	Test Conditions	Min.	Typ.	Max.	Unit
V_i	Input Voltage				20	V
V_o	Output Voltage	$V_i = 12\text{ to }18\text{ V}$ $I_o = 5\text{ to }150\text{ mA}$	8.1	8.5	8.9	V
$\Delta V_{I/O}$	Controlled Input-output Dropout Voltage	$V_i = 5\text{ to }10\text{ V}$ $I_o = 5\text{ to }150\text{ mA}$		1.6	2.1	V
ΔV_o	Line Regulation	$V_i = 12\text{ to }18\text{ V}$ $I_o = 10\text{ mA}$		1	20	mV
ΔV_o	Load Regulation	$I_o = 5\text{ to }250\text{ mA}$ $t_{on} = 30\text{ }\mu\text{s}$ $t_{off} \geq 1\text{ ms}$		50	100	mV
ΔV_o	Load Regulation (filter mode)	$V_i = 8.5\text{ V}$ $I_o = 5\text{ to }150\text{ mA}$ $t_{on} = 30\text{ }\mu\text{s}$ $t_{off} \geq 1\text{ ms}$		150	250	mV
I_q	Quiescent Current	$I_o = 5\text{ mA}$		1	2	mA
ΔI_q	Quiescent Current Change	$V_i = 6\text{ to }18\text{ V}$ $I_o = 5\text{ to }150\text{ mA}$		0.05		mA
$\frac{\Delta V_o}{\Delta T}$	Output Voltage Drift	$I_o = 10\text{ mA}$		1.2		mV/ $^{\circ}\text{C}$
SVR	Supply Voltage Rejection	$V_{iac} = 1\text{ V}_{rms}$ $f = 100\text{ Hz}$ $I_o = 150\text{ mA}$ $V_{DC} = 12\text{ to }18\text{ V}$ $V_{DC} = 6\text{ to }11\text{ V}$		70 35(*)		dB dB
I_{SC}	Short Circuit Current		250	300		mA
T_{on}	Switch On Time	$I_o = 150\text{ mA}$ $V_i = 5\text{ to }11\text{ V}$ $V_i = 11\text{ to }18\text{ V}$		500(*) 300		ms ms
T_J	Thermal Shutdown Junction Temperature			145		$^{\circ}\text{C}$

(*) Depending of the C_{FT} capacitor.**Figure 1** : Test and Application Circuit.

Figure 2 : P.C. Board and Component Layout of Fig. 1 (1 : 1 scale).



PRINCIPLE OF OPERATION

During normal operation (input voltage upper than $V_{I\ MIN} = V_{OUT\ NOM} + \Delta V_{I/O}$). The device works as a normal voltage regulator built around the OP1 of the block diagram.

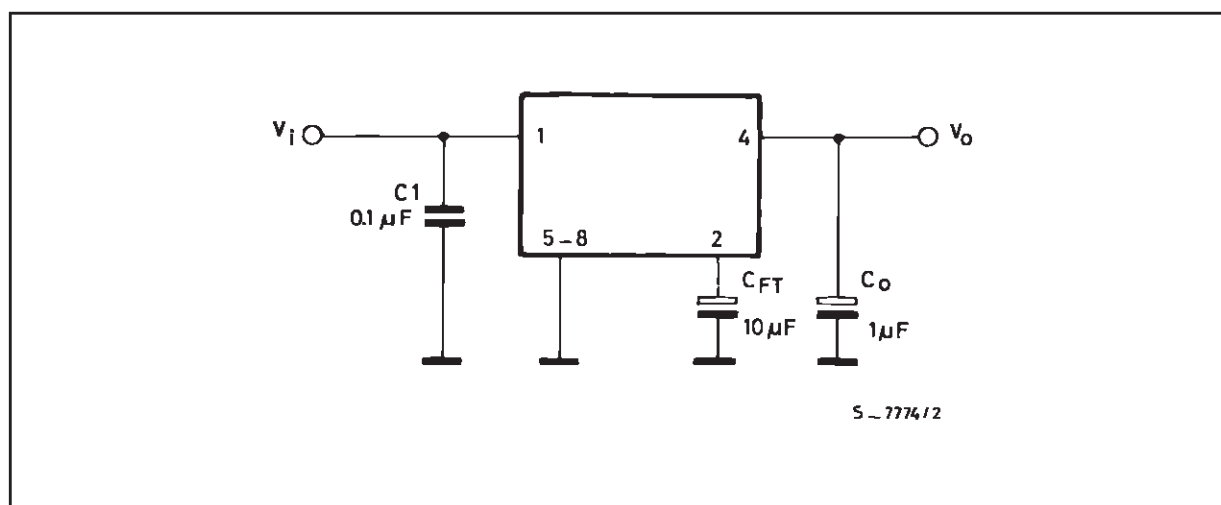
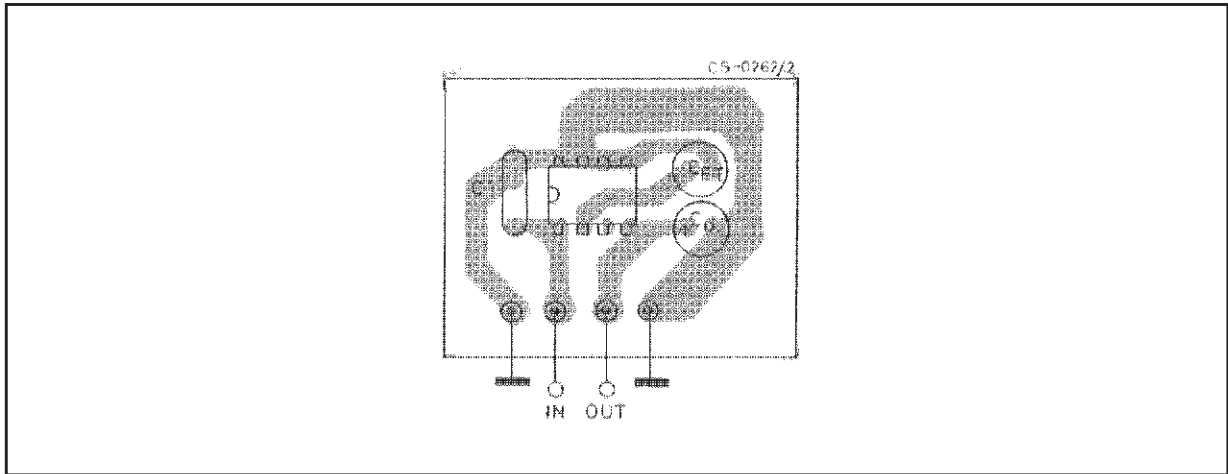
The series pass element use a PNP-NPN connection to reduce the dropout. The reference voltage of the OP1 is derived from a REF through the OP2 and Q3, acting as an active zener diode of value V_{REF} .

In this condition the device works in the range (1) of the characteristic of the non linear drop control unit (see fig.3).

The output voltage is fixed to its nominal value:

$$V_{OUT\ NOM} = V_{REF} \left(1 + \frac{R1}{R2} \right) = V_{CFT} \left(1 + \frac{R1}{R2} \right)$$

$$\frac{R1}{R2} = \text{INTERNALLY FIXED RATIO} = 2.4$$

The ripple rejection is quite high (70 dB) and independent from C_{FT} value.

On the usual voltage regulators, when the input voltage goes below the nominal value, the regulation transistors (series element) saturate bringing the system out of regulation making it very sensible to every variation of the input voltage. On the contrary, a control loop on the L4916 consents to avoid the saturation of the series element by regulating the value of the reference voltage (pin 2). In fact, whenever the input voltage decreases below $V_{I\ MIN}$ the supervisor loop, utilizing a non linear OTA, forces the reference voltage at pin 2 to decrease by discharging C_{FT} . So, during the static mode, when the

input voltage goes below V_{MIN} the drop out is kept fixed to about 1.6V. In this condition the device works as a low pass filter in the range (2) of the OTA characteristic. The ripple rejection is externally adjustable acting on C_{FT} as follows :

$$SVR(j\omega) = \left| \frac{V_i(j\omega)}{V_{out}(j\omega)} \right| = \left| 1 + \frac{10^{-6}}{\frac{g_m}{j\omega C_{FT}} \left(1 + \frac{R1}{R2} \right)} \right|$$

Where:

$g_m = 2 \cdot 10^{-5} \Omega^{-1}$ = OTA'S typical transconductance value on linear region

$\frac{R1}{R2}$ = fixed ratio

C_{FT} = value of capacitor in μF

The reaction time of the supervisor loop is given by the transconductance of the OTA and by C_{FT} . When the value of the ripple voltage is so high and its negative peak is fast enough to determine an instantaneous decrease of the dropout till 1.2 V, the OTA works in a higher transconductance condition [range (3) of the characteristic] and discharge the capacitor rapidly.

If the ripple frequency is high enough the capacitor won't charge itself completely, and the output voltage reaches a small value allowing a better ripple rejection ; the device's again working as a filter (fast transient range).

With $C_{FT} = 10 \mu F$; $f = 100\text{Hz}$ a SVR of 35 is obtained.

Figure 3 : Nonlinear Transfer Characteristic of the Drop Control Unit.

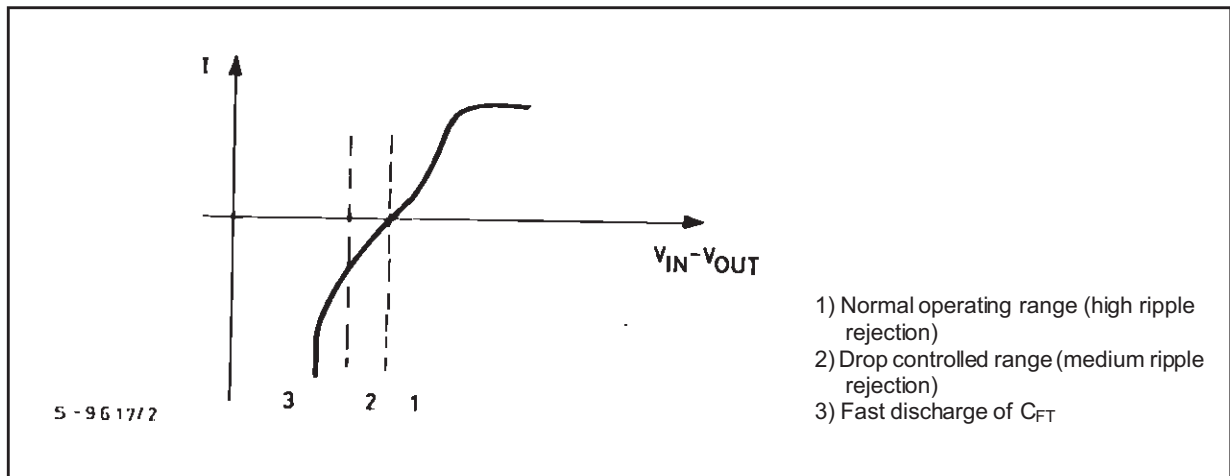

Figure 4 : Supply Voltage Rejection vs. Input Voltage.

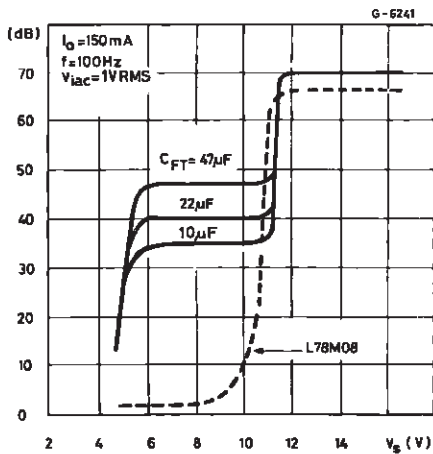

Figure 5 : Supply voltage Rejection vs. Frequency.

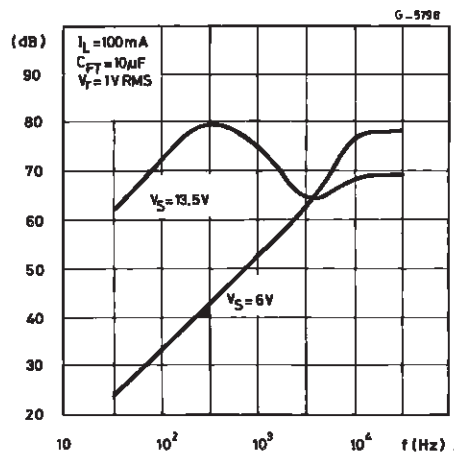

Figure 6 : VO vs. Supply Voltage.

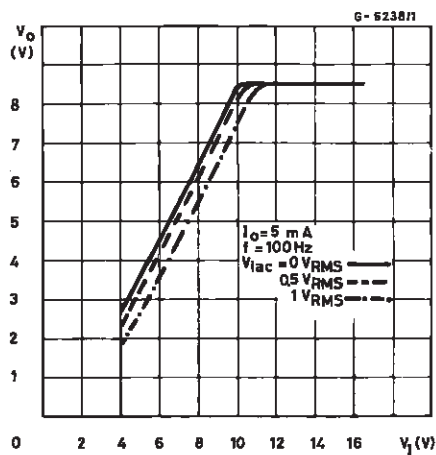

Figure 7 : Quiescent Current vs. Input Voltage.

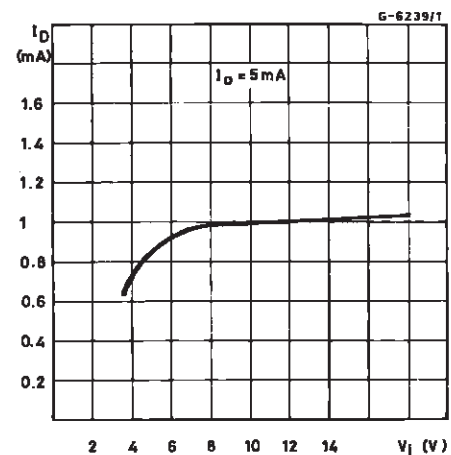

Figure 8 : Dropout vs. Load Current.

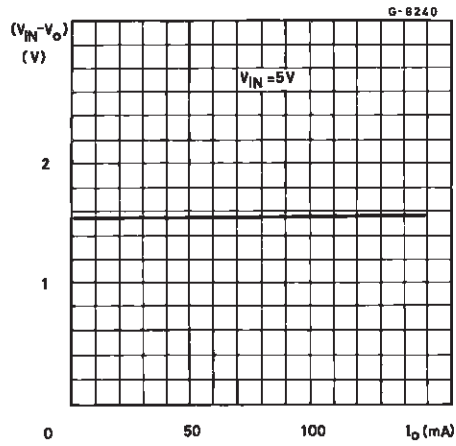
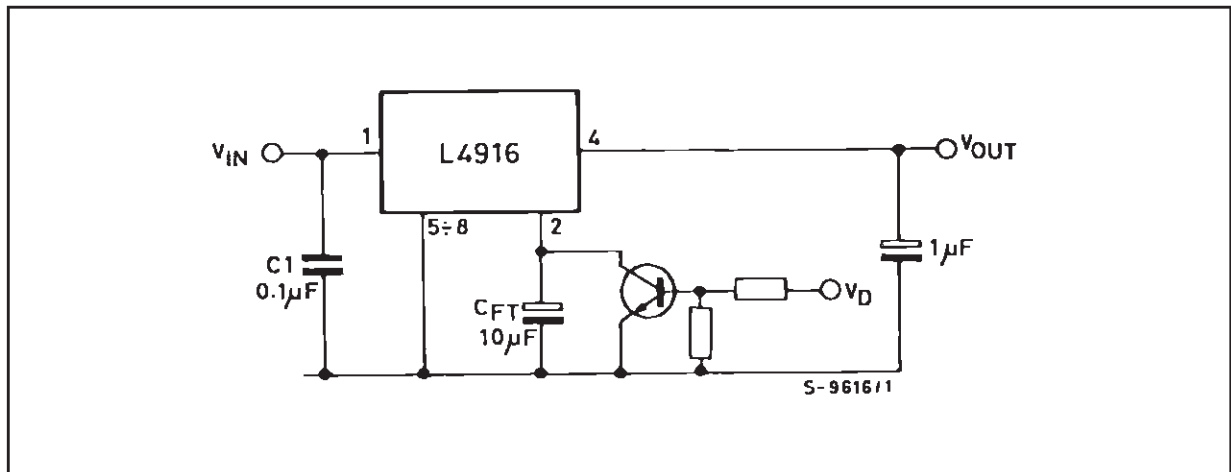
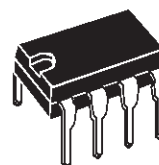

Figure 9 : Inhibit Function Realized on C_{FT} Pin.



DIM.	mm			inch		
	MIN.	TYP.	MAX.	MIN.	TYP.	MAX.
A		3.3			0.130	
a1	0.7			0.028		
B	1.39		1.65	0.055		0.065
B1	0.91		1.04	0.036		0.041
b		0.5			0.020	
b1	0.38		0.5	0.015		0.020
D			9.8			0.386
E		8.8			0.346	
e		2.54			0.100	
e3		7.62			0.300	
e4		7.62			0.300	
F			7.1			0.280
I			4.8			0.189
L		3.3			0.130	
Z	0.44		1.6	0.017		0.063

OUTLINE AND MECHANICAL DATA



PowerMinidip

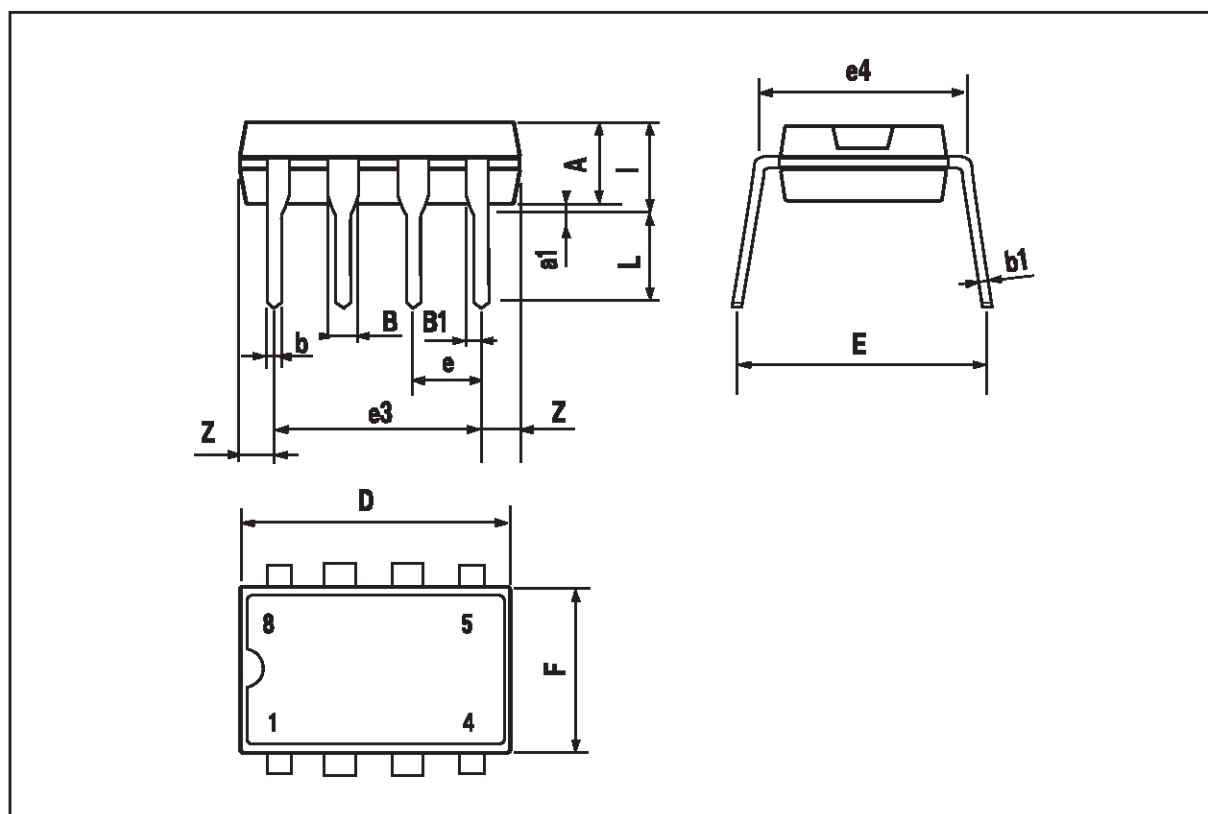

Information furnished is believed to be accurate and reliable. However, STMicroelectronics assumes no responsibility for the consequences of use of such information nor for any infringement of patents or other rights of third parties which may result from its use. No license is granted by implication or otherwise under any patent or patent rights of STMicroelectronics. Specification mentioned in this publication are subject to change without notice. This publication supersedes and replaces all information previously supplied. STMicroelectronics products are not authorized for use as critical components in life support devices or systems without express written approval of STMicroelectronics.

The ST logo is a registered trademark of STMicroelectronics
© 2000 STMicroelectronics – Printed in Italy – All Rights Reserved
STMicroelectronics GROUP OF COMPANIES

Australia - Brazil - China - Finland - France - Germany - Hong Kong - India - Italy - Japan - Malaysia - Malta - Morocco -
Singapore - Spain - Sweden - Switzerland - United Kingdom - U.S.A.

<http://www.st.com>