



## M51366SP

PLL-SPLIT VIF/SIF

## ABSOLUTE MAXIMUM RATINGS

Symbol	Parameter	Ratings	Unit
V <sub>cc</sub>	Supply voltage	14	V
P <sub>d</sub>	Power dissipation	1250	mW
T <sub>opr</sub>	Operating temperature	-20~75	°C
T <sub>stg</sub>	Storage temperature	-40~125	°C
Surge	Electrostatic discharge	±200	V

ELECTRICAL CHARACTERISTICS (T<sub>a</sub> = 25 °C, V<sub>CC</sub> = 9V, unless otherwise noted)

## VIF SECTION

Symbol	Parameter	Test circuit	Test point	Test conditions						Limits			Unit
				Input signal		External power supply(V)			* Switches should usually be set to 1	Min.	Typ.	Max.	
				VIF	SIF1	V <sub>1</sub>	V <sub>7</sub>	V <sub>20</sub>					
I <sub>cc</sub> (VIF)	Circuit current (VIF)	1	A1	-	-	3	-	-	SW1 = 2, SW2 = 3	33	45	57	mA
V <sub>28</sub>	Video detector output DC voltage 1	1	TP9	-	-	3	0	-	SW2 = 3, SW3 = 2	3.4	3.75	4.1	V
V <sub>3</sub>	Video detector output DC voltage 2	1	TP2	-	-	3	0	-	SW2 = 3, SW3 = 2	4.3	4.7	5.1	V
V <sub>o det1</sub>	Video detector output 1	1	TP9	SG1	-	3	-	-	SW2 = 3	1.15	1.45	1.75	V <sub>P-P</sub>
V <sub>o det2</sub>	Video detector output 2	1	TP2	SG1	-	3	-	-	SW2 = 3	1.75	2.2	2.65	V <sub>P-P</sub>
P/N	Video S/N	1	TP10	SG2	-	3	-	-	SW2 = 3, SW6 = 2 (Note 1)	50	58		dB
B <sub>w</sub>	Video frequency characteristics	1	TP9	SG3	-	3	-	-	SW2 = 3 (Note 2)	5.0	6.5		MHz
V <sub>in</sub> (min)	Input sensitivity	1	TP9	SG4	-	3	-	-	SW2 = 3 (Note 3)		46	51	dB μ
V <sub>in</sub> (max)	Maximum allowable input	1	TP9	SG5	-	3	-	-	SW2 = 3 (Note 4)	107	110		dB μ
GR	AGC control range	1	-	-	-	-	-	-	(Note 5)	58	64		dB
V <sub>IH</sub>	IF AGC maximum voltage	1	TP3	-	-	3	-	-	SW2 = 3	6.5	8.6		V
V <sub>I</sub> (80dBμ)	IF AGC voltage (80dBμ)	1	TP3	SG6	-	3	-	-	SW2 = 3	4.1	4.7	5.3	V
V <sub>IL</sub>	IF AGC minimum voltage	1	TP3	SG7	-	3	-	-	SW2 = 3	3.4	3.9	4.4	V
V <sub>o SIF-1</sub>	SIF det, 4.5MHz output (100dB μ)	1	TP4	SG2	SG8	3	-	-	SW2 = 3	104	109	114	dB μ
V <sub>o SIF-2</sub>	SIF det, 4.5MHz output (80dB μ)	1	TP4	SG2	SG9	3	-	-	SW2 = 3	90	96	101	dB μ
V <sub>16</sub>	AFT output voltage	1	TP5	-	-	3	0	-	SW2 = 3	3.2	4.3	5.4	V
μ	AFT detector sensitivity	1	TP5	SG10	-	3	-	-	SW2 = 3 (Note 6)	48	70	92	mV/kHz
V <sub>16H</sub>	AFT maximum voltage	1	TP5	SG10	-	3	-	-	SW2 = 3 (Note 7)	8	8.7		V
V <sub>16L</sub>	AFT minimum voltage	1	TP5	SG10	-	3	-	-	SW2 = 3 (Note 8)		0.38	1.0	V
V <sub>1H</sub>	RF AGC maximum voltage	1	TP1	SG2	-	2	-	-	SW2 = 3	6.9	7.8		V
V <sub>1L</sub>	RF AGC minimum voltage	1	TP1	SG2	-	4	-	-	SW2 = 3		0	1.0	V
CL-U1	Capture range (U)	1	TP9	SG11	-	3	-	-	SW2 = 3 (Note 9)	0.5	1.0		MHz
CL-L1	Capture range (L)	1	TP9	SG11	-	3	-	-	SW2 = 3 (Note 10)	1.2	1.7		MHz
CL-T	Capture range (T)	1	-	-	-	-	-	-	(Note 11)	2.0	2.7		MHz
CL-U2	Capture range (U)	1	TP9	SG11	-	3	-	-	SW2 = 3, SW5 = 2 (Note 9)	0.45	1.0	1.60	MHz
CL-L2	Capture range (L)	1	TP9	SG11	-	3	-	-	SW2 = 3, SW5 = 2 (Note 10)	0.95	1.5	2.05	MHz
V <sub>20TH</sub>	Lock detector threshold voltage	1	TP8	-	-	3	5	Variable	SW2 = 3, SW3, 4, 5 = 2 (Note 12)	3.6	4.0	4.4	V
V <sub>29L</sub>	Minimum voltage at pin ②	1	TP8	-	-	3	5	Variable	SW2 = 3, SW3, 4, 5 = 2 (Note 13)		0.15	0.5	V

## M51366SP

## PLL-SPLIT VIF/SIF

## VIF SECTION (cont.)

Symbol	Parameter	Test circuit	Test point	Test conditions						Limits			Unit
				Input signal		External power supply(V)			* Switches should usually be set to 1	Min.	Typ.	Max.	
				VIF	SIF1	V <sub>1</sub>	V <sub>7</sub>	V <sub>20</sub>					
FC1	EQ frequency characteristics 1	1	TP9 TP2	SG12	-	3	-	-	SW2 = 3 (Note 14)	2.0	3.5	5.0	dB
FC2	EQ frequency characteristics 2	1	TP9 TP2	SG13	-	3	-	-	SW2 = 3 (Note 14)	4.2	5.7	7.2	dB
FC3	EQ frequency characteristics 3	1	TP9 TP2	SG14	-	3	-	-	SW2 = 3 (Note 14)	9.5	12.0	14.5	dB
IM	Intermodulation	1	TP9	SG15	-	3	Variable	-	SW2 = 3, SW3 = 2 (Note 15)	30	35		dB
DG	DG	1	TP9	SG16	-	3	-	-	SW2 = 3 (Note 16)		2	5	%
DP	DP	1	TP9	SG16	-	3	-	-	SW2 = 3 (Note 16)		2	5	deg.
V <sub>BTH</sub>	Black spot inverter threshold level	1	TP2	SG1	-	3	Variable	-	SW2 = 3, SW3 = 2 (Note 17)	1.0	1.4	1.8	V
V <sub>BCL</sub>	Black spot inverter clamp level	1	TP2	SG1	-	3	Variable	-	SW2 = 3, SW3 = 2 (Note 17)	3.7	4.2	4.7	V
V <sub>SYNC</sub>	Sync tip level at pin ③	1	TP2	SG2	-	3	-	-	SW2 = 3	1.8	2.2	2.6	V
R <sub>in</sub> (v)	VIF input resistance	2		90dB $\mu$	-	3	-	-			0.95		k $\Omega$
C <sub>in</sub> (v)	VIF input capacitance	2		90dB $\mu$	-	3	-	-			5		pF
R <sub>in</sub> (s1)	SIF1 input resistance	2		-	90dB $\mu$	3	-	-			2.1		k $\Omega$
C <sub>in</sub> (s1)	SIF1 input capacitance	2		-	90dB $\mu$	3	-	-			2.5		pF

## SIF SECTION

Symbol	Parameter	Test circuit	Test point	Test conditions						Limits			Unit
				Input signal		External power supply(V)			* Switches should usually be set to 1	Min.	Typ.	Max.	
				SIF2	V <sub>1</sub>	V <sub>7</sub>	V <sub>20</sub>						
I <sub>CC</sub> (SIF)	Circuit current (SIF)	1	A2	-	0	-	-	-	SW1 = 3, SW2 = 2	5.0	7.2	9.4	mA
V <sub>19</sub>	AF output DC voltage	1	TP6	-	0	-	-	-	SW1 = 3	4.1	4.7	5.3	V
V <sub>OAFMAX</sub>	Maximum AF output	1	TP6	SG17	0	-	-	-	SW1 = 3	530	680	830	mVrms
THDAF	AF output distortion	1	TP6	SG21	0	-	-	-	SW1 = 3		0.4	1.2	%
V <sub>in</sub> (lim)	Input limiting sensitivity	1	TP6	SG18	0	-	-	-	SW1 = 3 (Note 18)		38	46	dB $\mu$
AMR	AMR	1	TP6	SG19	0	-	-	-	SW1 = 3 (Note 19)	50	60		dB
S/N	AF S/N	1	TP6	SG20	0	-	-	-	SW1 = 3 (Note 20)	60	75		dB

# M51366SP

## PLL-SPLIT VIF/SIF

### ELECTRICAL CHARACTERISTICS TEST METHOD

#### Note1. Video S/N "P/N"

- a. Input SG6 in VIF IN.
- b. The noise appearing at pin ② is determined by measuring the r.m.s. voltage at TP10 through low pass filter (-3dB at 5MHz).

$$c. P/N = 20 \log \left\{ \frac{V_{odet\ 1} (V_{P-P}) \times 0.7}{noise (V_{rms})} \right\}$$

where Vodet 1 denotes video detection output 1.

#### Note2. Video frequency characteristics "Bw"

- a. Set SG3 as follows:
 

$f_1 = 45.75\text{MHz}$	$V_i = 90\text{dB}\mu$	}	mixed signal
$f_2 = 45.75\text{MHz}$	$V_i = 70\text{dB}\mu$		
- b. Measure element of 1MHz at TP9 at this time and it is defined as  $V_1$ .
- c. Decrease the frequency until element ( $f_1-f_2$ ) becomes 3dB smaller than  $V_1$  and then, read the frequency.
- d.  $Bw = 45.75 - f_2$  (MHz)

#### Note3. Input sensitivity "Vin (min)"

- a. Input SG4 in VIF IN.
- b. Decrease the SG4 level and the level at which detector output at pin ② reaches 3dB smaller than Vodet 1 is defined as input sensitivity.

#### Note4. Maximum allowable input "Vin (max)"

- a. Set SG5 to 90dB $\mu$  and input it in VIF IN.
- b. Detector output at pin ② at this time is defined as  $V_2$ .
- c. Increase the SG5 and the voltage at which detector output reaches 3dB smaller than  $V_2$  is defined as maximum allowable input.

#### Note5. AGC control range "GR"

- a. AGC control range is defined as follows:  
 $GR = \text{Maximum allowable input} - \text{Input sensitivity}$

#### Note6. AFT detector sensitivity " $\mu$ "

- a. Input SG10 in VIF IN.
- b. Measure difference of frequency between 3.0V and 6.0V of DC voltage at TP5 and it is defined as  $\Delta f$ .
- c. AFT detector sensitivity  $\mu$  is defined as follows:

$$\mu = \frac{3000\text{mV}}{\Delta f \text{ (kHz)}} \text{ (mV/kHz)}$$

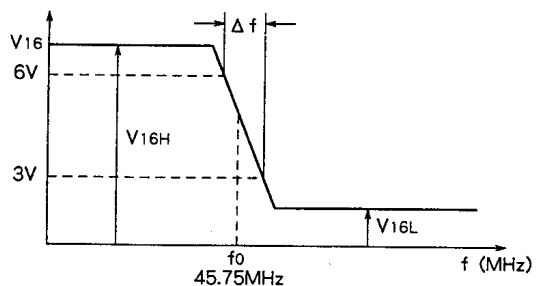

#### Note7. AFT maximum voltage "V16H"

- a. Maximum DC voltage in the above figure is defined as  $V_{16H}$ .

#### Note8. AFT minimum voltage "V16L"

- a. Minimum DC voltage in the above figure is defined as  $V_{16L}$ .

#### Note9. Capture range (U) "CL-U-1," "CL-U-2"

- a. Input SG11 in VIF IN and increase the frequency till VCO lock is released.
- b. Decrease the frequency of SG11 and the frequency at which VCO locks again is defined as  $f_v$  (MHz).
- c. Capture range (U) is defined as  $f_v - 45.75$  (MHz).

#### Note10. Capture range (L) "CL-L-1," "CL-L-2"

- a. Input SG11 in VIF IN and decrease the frequency until VCO lock is released.
- b. Increase the frequency of SG11 and the frequency at which VCO locks again is defined as  $f_L$  (MHz).
- c. Capture range (L) is defined as  $45.75 - f_L$  (MHz).

#### Note11. Capture range (T) "CT-T"

- a. "CL-T" is defined as "CL-U-1" + "CL-L-1" (MHz).

#### Note12. Lock detector threshold voltage "V20TH"

- a. Set the voltage at  $V_{20}$  to 3V and observe TP8.
- b. Increase the voltage at  $V_{20}$  and the point at which TP8 voltage changes drastically is defined as  $V_{20TH}$  (threshold 1V).

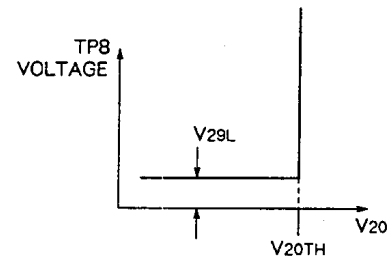

#### Note13. Minimum voltage at pin ② "V29L"

- a. Minimum voltage in Note12 is defined as  $V_{29L}$ .

#### Note14. EQ frequency characteristics "FC1", "FC2", "FC3"

- a. Input SG12, SG13 or SG14 in VIF IN.
- b. Measure the level of element ( $f_1-f_2$ ) at TP9 and it is defined as  $V_{EQ\ IN}$  (dB $\mu$ ).
- c. Measure the level of element ( $f_1-f_2$ ) at TP2 and it is defined as  $V_{EQ\ OUT}$  (dB $\mu$ ).
- d. EQ frequency characteristics is defined as follows:  
 $FC1\sim3 = V_{EQ\ OUT} - V_{EQ\ IN}$  (dB)

#### Note15. Intermodulation "IM"

- a. Input SG15 in VIF IN.
- b. Observe TP9 with oscilloscope, and adjust the voltage of  $V_6$  so that the minimum level of detector output waveform will come to 2V.

c. Observe TP9 with spectrum analyzer, and the ratio of the 920kHz level to the 3.58MHz level is defined as intermodulation.



**Note16. DG, DP “DG, DP”**

- a. Modulated waves of SG16 is generated by 87.5% video modulation of the 10-step waves as shown in the figure below.
- b. Measure DG and DP at TP9 with vectorscope.

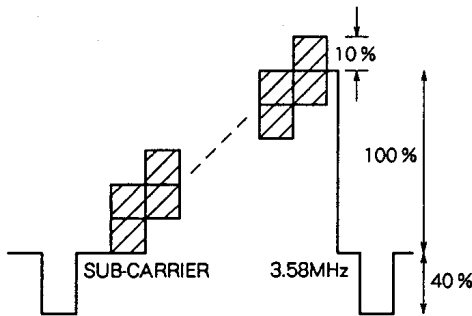

**Note17. Black spot inverter threshold level and clamp level “V<sub>B TH</sub>, V<sub>B CL</sub>”**

- a. Input SG1 in VIF IN.
- b. By varying V<sub>o</sub>, output the waveform as shown in the figure below to TP2 and measure each DC voltage.

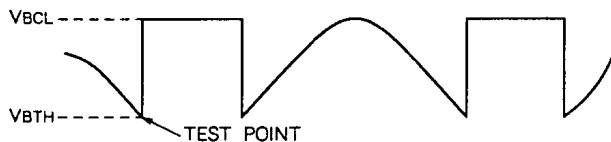

**Note18. Input limiting sensitivity “V<sub>in (lim)</sub>”**

- a. Set SG18 to 80dBμ and input it in SIF2 IN.
- b. Decrease the output level of SG18 until detector output at TP6 becomes 3dB smaller than V<sub>o AF MAX</sub>.  
The level of SG18 at this time is defined as input limiting sensitivity.

**Note19. AMR “AMR”**

- a. Input SG19 in SIF2 IN.
- b. Measure the output voltage at TP6 and it is defined as V<sub>AM</sub>.
- c. AMR is defined as follows:

$$AMR = 20 \log \left\{ \frac{V_{O AF MAX} (mVrms)}{V_{AM} (mVrms)} \right\} (dB)$$

**Note20. AF S/N “S/N”**

- a. Input SG20 in SIF2 IN.
- b. Measure the output voltage at TP6 and it is defined as V<sub>N</sub>.
- c. AF S/N is defined as follows:

$$S/N = 20 \log \left\{ \frac{V_{O AF MAX} (mVrms)}{V_N (mVrms)} \right\} (dB)$$

- \* • Amplitude level of all AM modulated waves is the peak level of modulated waves.
- The following is used for the mixer:

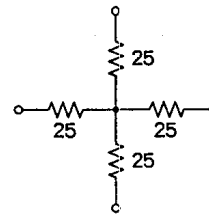

- With V<sub>co</sub> coil, IF AGC 0V and non-input condition, adjust free run frequency to 45.75MHz.

## INPUT SIGNAL

SG No.	Input Signal (with 50 $\Omega$ Termination)
SG1	$f_0=45.75\text{MHz}$ $V_i=90\text{dB}\mu$ 77.78%AM (87.5% Video modulation equivalent $f_m=20\text{kHz}$ )
SG2	$f_0 = 45.75\text{MHz}$ $V_i = 90\text{dB}\mu$
SG3	$f_1 = 45.75\text{MHz}$ $V_i = 90\text{dB}\mu$ $f_2 = 40 \pm 5\text{MHz}$ $V_i = 70\text{dB}\mu$ } mixed signal
SG4	$f_0 = 45.75\text{MHz}$ $V_i = \text{Vaviable}$ $f_m = 20\text{kHz}$ 77.78% AM
SG5	$f_0 = 45.75\text{MHz}$ $V_i = \text{Vaviable}$ $f_m = 20\text{kHz}$ 16% AM
SG6	$f_0 = 45.75\text{MHz}$ $V_i = 80\text{dB}\mu$
SG7	$f_0 = 45.75\text{MHz}$ $V_i = 110\text{dB}\mu$
SG8	$f_0 = 41.25\text{MHz}$ $V_i = 100\text{dB}\mu$
SG9	$f_0 = 41.25\text{MHz}$ $V_i = 80\text{dB}\mu$
SG10	$f_0 = 45.75\text{MHz} \pm 5\text{MHz}$ $V_i = 90\text{dB}\mu$
SG11	$f_0=45.75\text{MHz} \pm 5\text{MHz}$ $V_i=90\text{dB}\mu$ $f_m=20\text{kHz}$ 77.78%AM
SG12	$f_1 = 45.75\text{MHz}$ $V_i = 90\text{dB}\mu$ $f_2 = 45.25\text{MHz}$ $V_i = 60\text{dB}\mu$ } mixed signal
SG13	$f_1 = 45.75\text{MHz}$ $V_i = 90\text{dB}\mu$ $f_2 = 42.75\text{MHz}$ $V_i = 60\text{dB}\mu$ } mixed signal
SG14	$f_1 = 45.75\text{MHz}$ $V_i = 90\text{dB}\mu$ $f_2 = 41.25\text{MHz}$ $V_i = 60\text{dB}\mu$ } mixed signal
SG15	$f_1 = 45.75\text{MHz}$ $V_i = 90\text{dB}\mu$ $f_2 = 42.17\text{MHz}$ $V_i = 80\text{dB}\mu$ $f_3 = 41.25\text{MHz}$ $V_i = 80\text{dB}\mu$ } mixed signal
SG16	$f_0 = 45.75\text{MHz}$ Standard 10-step wave modulation $m = 87.5\%$ Video modulation Sync chip level 90dB $\mu$
SG17	$f_0 = 4.5\text{MHz} \pm 25\text{kHz}$ dev $V_i = 100\text{dB}\mu$ $f_m = 400\text{Hz}$
SG18	$f_0 = 4.5\text{MHz} \pm 25\text{kHz}$ dev $V_i = \text{Vaviable}$ $f_m = 400\text{Hz}$
SG19	$f_0 = 4.5\text{MHz}$ $V_i = 100\text{dB}\mu$ 30% AM $f_m = 400\text{Hz}$
SG20	$f_0 = 4.5\text{MHz}$ $V_i = 100\text{dB}\mu$



TYPICAL CHARACTERISTICS

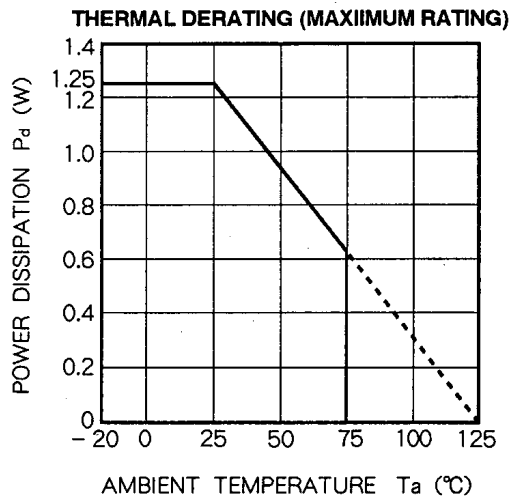

APPLICATION EXAMPLE

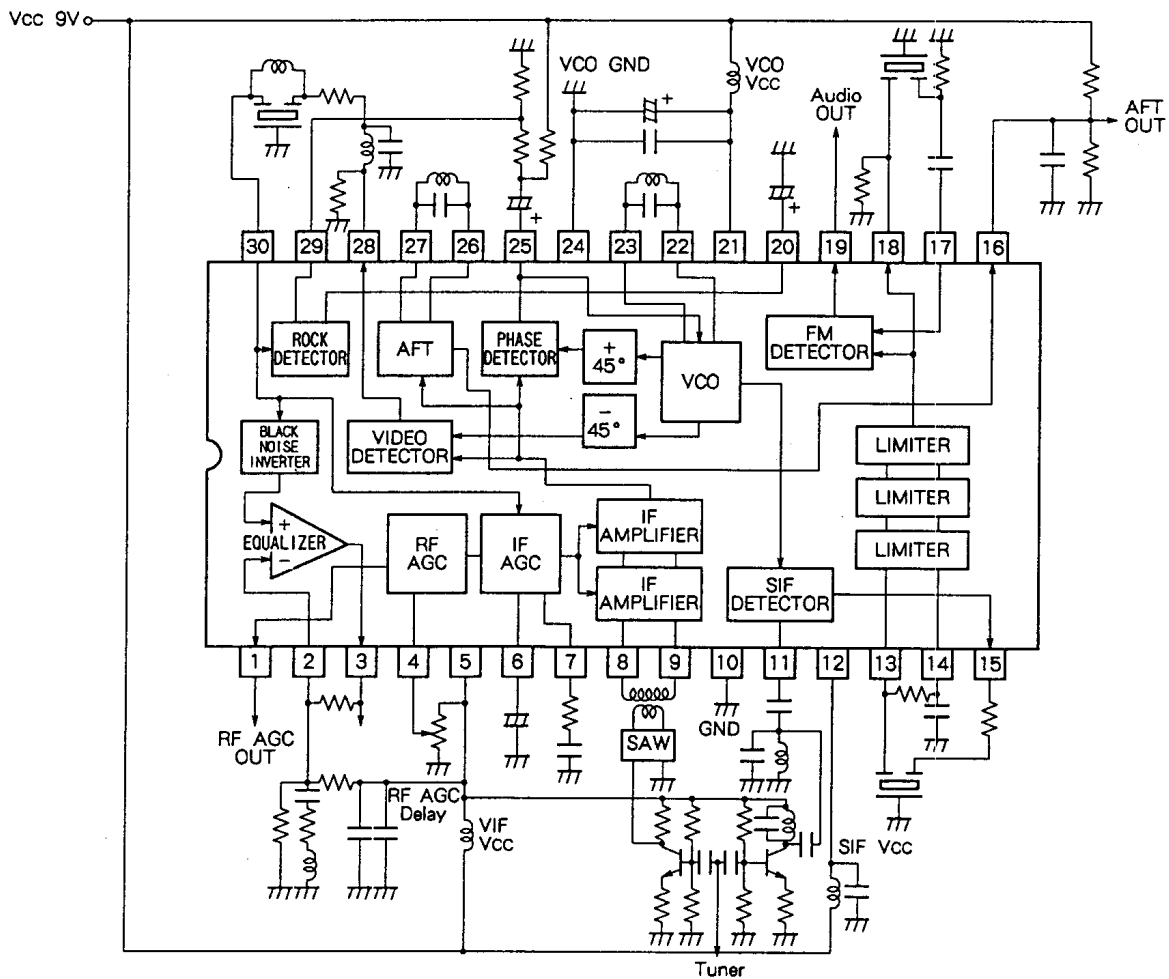



**PRECAUTIONS FOR APPLICATION****Note:**

- Amplitude level of all AM modulated waves shall be the peak level of modulated waves.
- The following is used for the mixer:

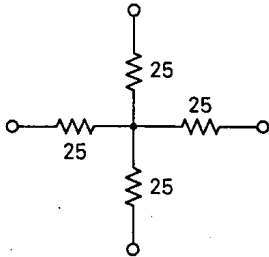

- With Vco coil, IF AGC 0V and non-input condition, adjust free run frequency to 45.75MHz.