

SA08-11GWA

GREEN

Features

- 0.8 INCH DIGIT HEIGHT.
- LOW CURRENT OPERATION.
- EXCELLENT CHARACTER APPEARANCE.
- EASY MOUNTING ON P.C. BOARDS OR SOCKETS.
- I.C. COMPATIBLE.
- CATEGORIZED FOR LUMINOUS INTENSITY.
- MECHANICALLY RUGGED.
- STANDARD : GRAY FACE, WHITE SEGMENT.
- RoHS COMPLIANT.

Description

The Green source color devices are made with Gallium Phosphide Green Light Emitting Diode.

Package Dimensions & Internal Circuit Diagram

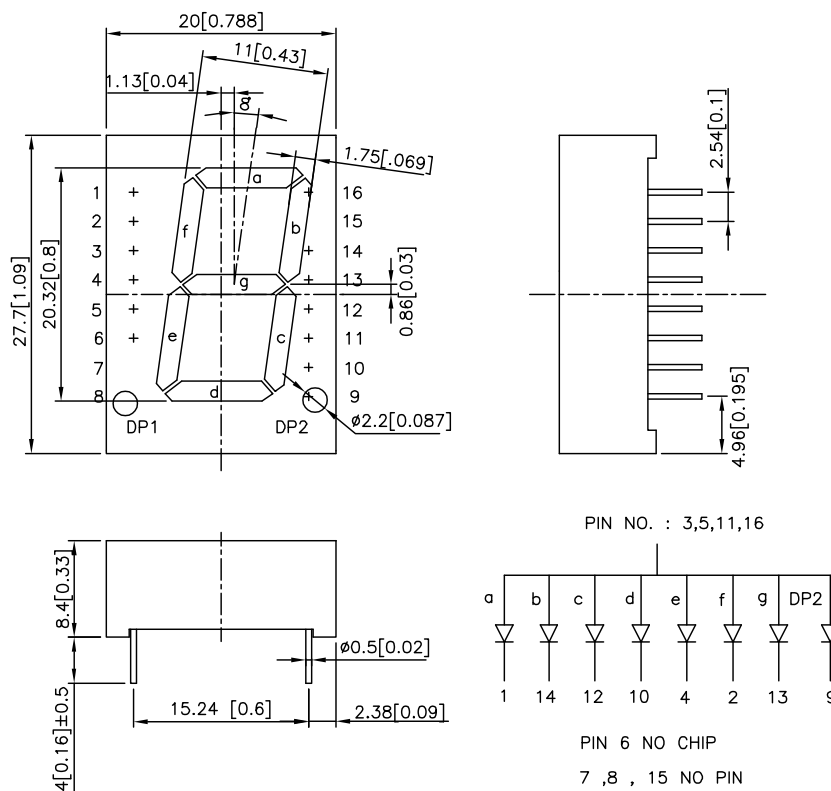

Notes:

1. All dimensions are in millimeters (inches), Tolerance is $\pm 0.25(0.01)$ unless otherwise noted.
2. Specifications are subject to change without notice.

Selection Guide

Part No.	Dice	Lens Type	Iv (ucd) @ 10mA		Description
			Min.	Typ.	
SA08-11GWA	GREEN(GaP)	WHITE DIFFUSED	1900	10500	Common Anode,Rt. Hand Decimal.

Electrical / Optical Characteristics at TA=25°C

Symbol	Parameter	Device	Typ.	Max.	Units	Test Conditions
λ_{peak}	Peak Wavelength	Green	565		nm	IF=20mA
λ_D	Dominant Wavelength	Green	568		nm	IF=20mA
$\Delta\lambda_{1/2}$	Spectral Line Half-width	Green	30		nm	IF=20mA
C	Capacitance	Green	15		pF	VF=0V;f=1MHz
VF	Forward Voltage	Green	2.2	2.5	V	IF=20mA
IR	Reverse Current	Green		10	uA	VR = 5V

Absolute Maximum Ratings at TA=25°C

Parameter	Green	Units
Power dissipation	105	mW
DC Forward Current	25	mA
Peak Forward Current [1]	140	mA
Reverse Voltage	5	V
Operating/Storage Temperature	-40°C To +85°C	
Lead Solder Temperature [2]	260°C For 5 Seconds	

Notes:

- 1/10 Duty Cycle, 0.1ms Pulse Width.
- 2mm below package base.

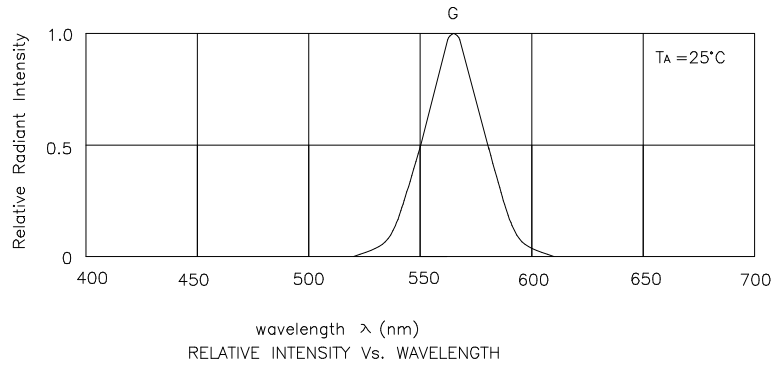

Green

SA08-11GWA

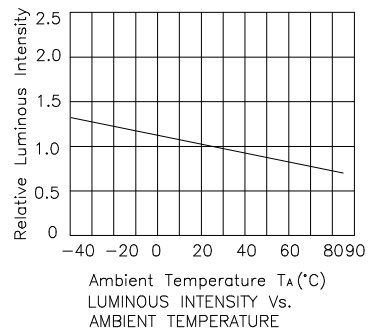
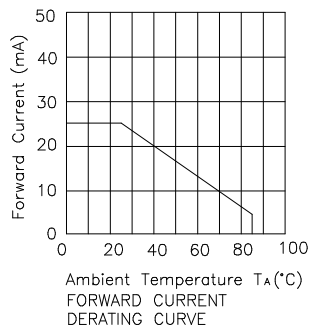
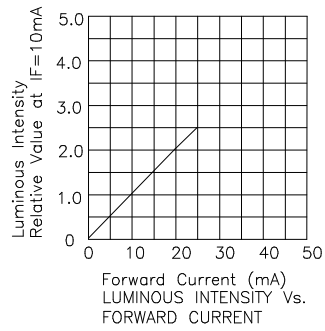
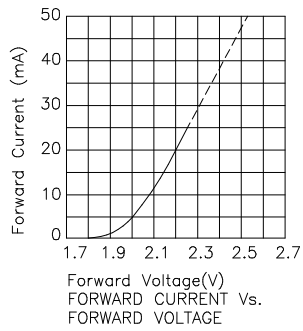

PACKING & LABEL SPECIFICATIONS

SA08-11GWA

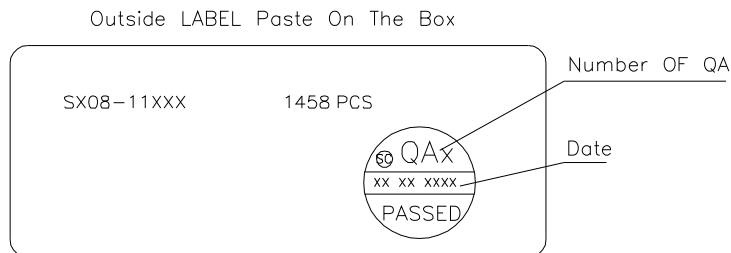
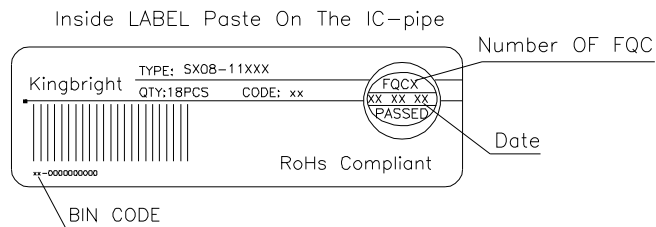
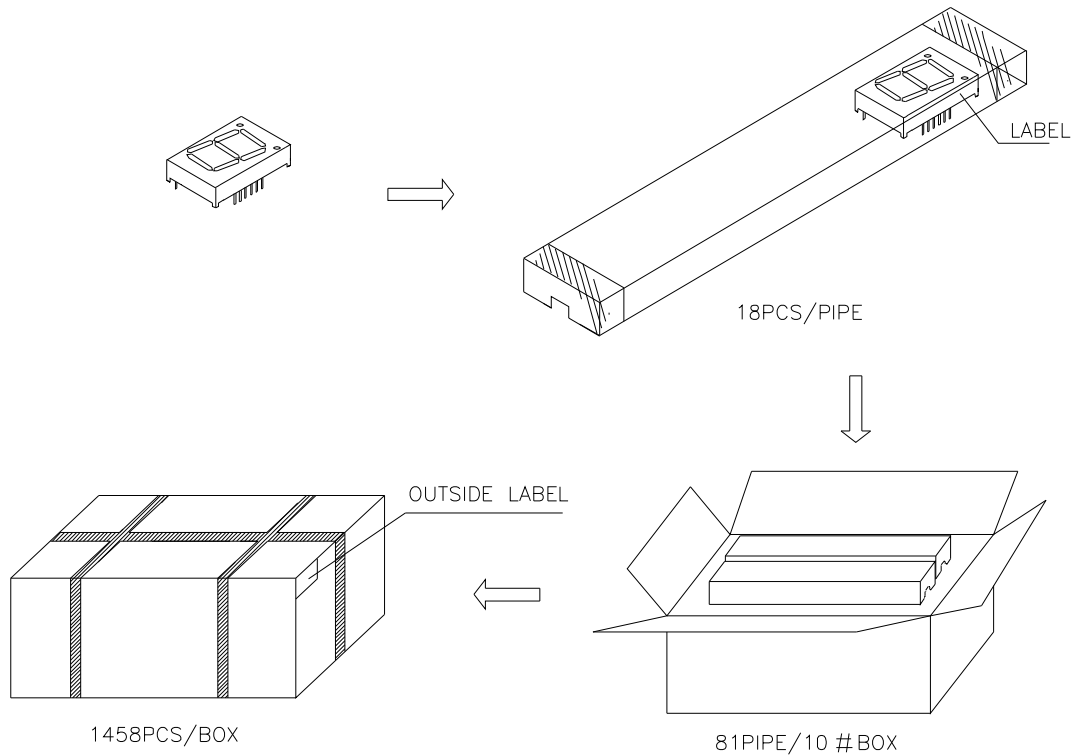

Remarks:

If special sorting is required (e.g. binning based on forward voltage, Luminous intensity/ luminous flux, or wavelength), the typical accuracy of the sorting process is as follows:

1. Wavelength: +/-1nm
2. Luminous intensity/ luminous flux: +/-15%
3. Forward Voltage: +/-0.1V

Note: Accuracy may depend on the sorting parameters.