

Power MOSFET

200 mAmps, 50 Volts

N-Channel SOT-23

Typical applications are dc-dc converters, power management in portable and battery-powered products such as computers, printers, PCMCIA cards, cellular and cordless telephones.

- Low Threshold Voltage ($V_{GS(th)}$: 0.5V...1.5V) makes it ideal for low voltage applications
- Miniature SOT-23 Surface Mount Package saves board space
- Pb-Free Package May be Available. The G-Suffix Denotes a Pb-Free Lead Finish

MAXIMUM RATINGS ($T_A = 25^\circ\text{C}$ unless otherwise noted)

Rating	Symbol	Value	Unit
Drain-to-Source Voltage	V_{DSS}	50	Vdc
Gate-to-Source Voltage – Continuous	V_{GS}	± 20	Vdc
Drain Current			mA
– Continuous @ $T_A = 25^\circ\text{C}$	I_D	200	
– Pulsed Drain Current ($t_p \leq 10 \mu\text{s}$)	I_{DM}	800	
Total Power Dissipation @ $T_A = 25^\circ\text{C}$	P_D	225	mW
Operating and Storage Temperature Range	T_J, T_{stg}	- 55 to 150	$^\circ\text{C}$
Thermal Resistance – Junction-to-Ambient	$R_{\theta JA}$	556	$^\circ\text{C/W}$
Maximum Lead Temperature for Soldering Purposes, for 10 seconds	T_L	260	$^\circ\text{C}$

LBSS138LT1G

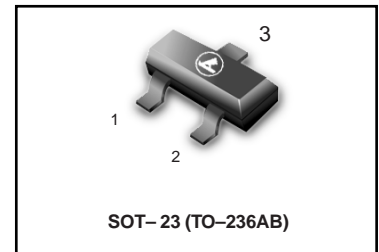

200 mAmps
50 Volts
 $R_{DS(on)} = 3.5 \Omega$

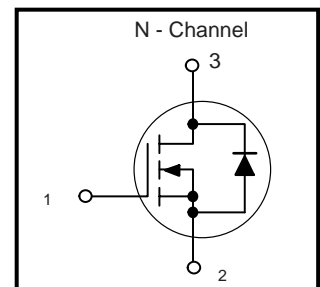

MARKING DIAGRAM & PIN ASSIGNMENT

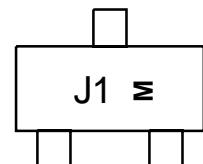

J1 = Device Code
M = Month Code

ORDERING INFORMATION

Device	Package	Shipping
LBSS138LT1G	SOT-23	3000 Tape & Reel
LBSS138LT3G	SOT-23	10000 Tape & Reel

LBSS138LT1G

ELECTRICAL CHARACTERISTICS ($T_A = 25^\circ\text{C}$ unless otherwise noted)

Characteristic	Symbol	Min	Typ	Max	Unit
OFF CHARACTERISTICS					
Drain-to-Source Breakdown Voltage ($V_{GS} = 0\text{ Vdc}$, $I_D = 250\ \mu\text{Adc}$)	$V_{(BR)DSS}$	50	–	–	Vdc
Zero Gate Voltage Drain Current ($V_{DS} = 25\text{ Vdc}$, $V_{GS} = 0\text{ Vdc}$) ($V_{DS} = 50\text{ Vdc}$, $V_{GS} = 0\text{ Vdc}$)	I_{DSS}	– –	– –	0.1 0.5	μAdc
Gate-Source Leakage Current ($V_{GS} = \pm 20\text{ Vdc}$, $V_{DS} = 0\text{ Vdc}$)	I_{GSS}	–	–	± 0.1	μAdc

ON CHARACTERISTICS (Note 1.)

Gate-Source Threshold Voltage ($V_{DS} = V_{GS}$, $I_D = 1.0\text{ mAdc}$)	$V_{GS(th)}$	0.5	–	1.5	Vdc
Static Drain-to-Source On-Resistance ($V_{GS} = 2.75\text{ Vdc}$, $I_D < 200\text{ mAdc}$, $T_A = -40^\circ\text{C}$ to $+85^\circ\text{C}$) ($V_{GS} = 5.0\text{ Vdc}$, $I_D = 200\text{ mAdc}$)	$r_{DS(on)}$	– –	5.6 –	10 3.5	Ohms
Forward Transconductance ($V_{DS} = 25\text{ Vdc}$, $I_D = 200\text{ mAdc}$, $f = 1.0\text{ kHz}$)	g_{fs}	100	–	–	mmhos

DYNAMIC CHARACTERISTICS

Input Capacitance	($V_{DS} = 25\text{ Vdc}$, $V_{GS} = 0$, $f = 1\text{ MHz}$)	C_{iss}	–	40	50	pF
Output Capacitance	($V_{DS} = 25\text{ Vdc}$, $V_{GS} = 0$, $f = 1\text{ MHz}$)	C_{oss}	–	12	25	
Transfer Capacitance	($V_{DG} = 25\text{ Vdc}$, $V_{GS} = 0$, $f = 1\text{ MHz}$)	C_{rss}	–	3.5	5.0	

SWITCHING CHARACTERISTICS (Note 2.)

Turn-On Delay Time	($V_{DD} = 30\text{ Vdc}$, $I_D = 0.2\text{ Adc}$,)	$t_{d(on)}$	–	–	20	ns
Turn-Off Delay Time		$t_{d(off)}$	–	–	20	

1. Pulse Test: Pulse Width $\leq 300\ \mu\text{s}$, Duty Cycle $\leq 2\%$.
2. Switching characteristics are independent of operating junction temperature.

TYPICAL ELECTRICAL CHARACTERISTICS

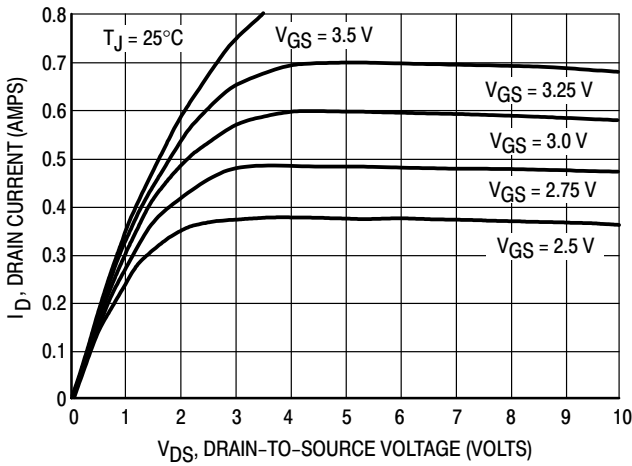

Figure 1. On-Region Characteristics

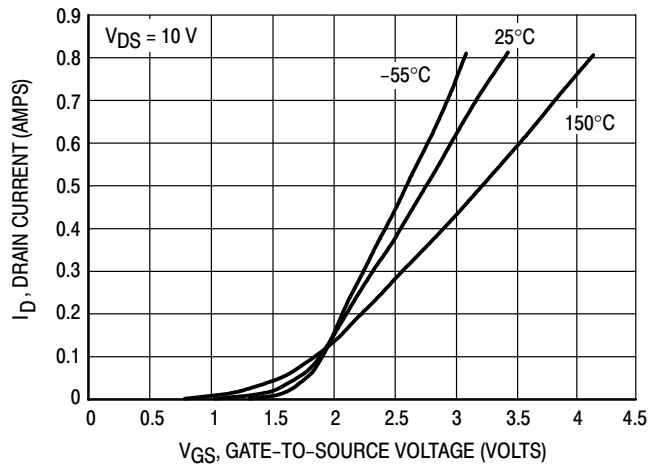

Figure 2. Transfer Characteristics

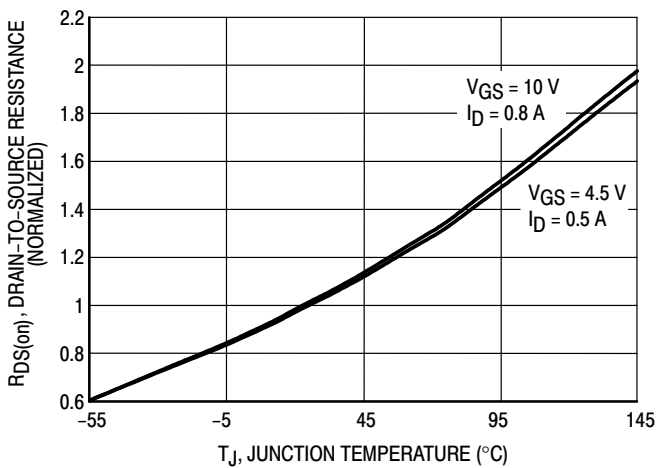

Figure 3. On-Resistance Variation with Temperature

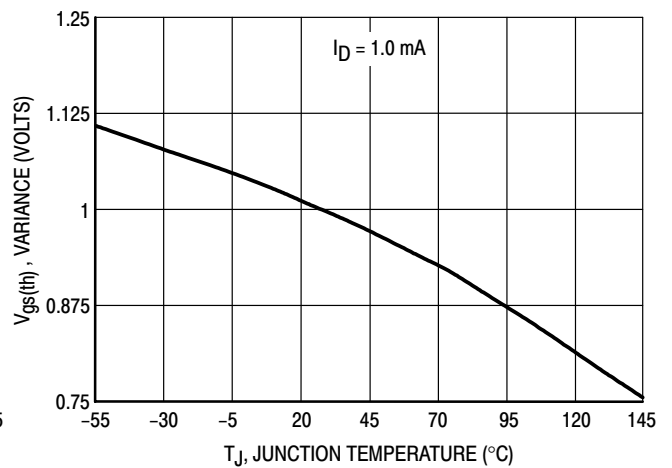

Figure 4. Threshold Voltage Variation with Temperature

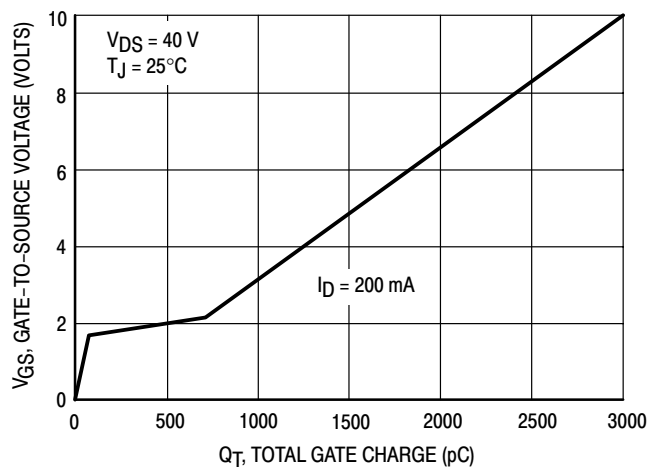

Figure 5. Gate Charge

TYPICAL ELECTRICAL CHARACTERISTICS

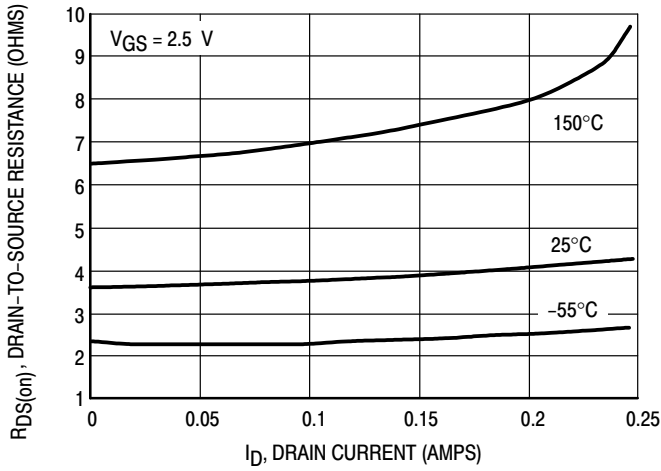

Figure 6. On-Resistance versus Drain Current

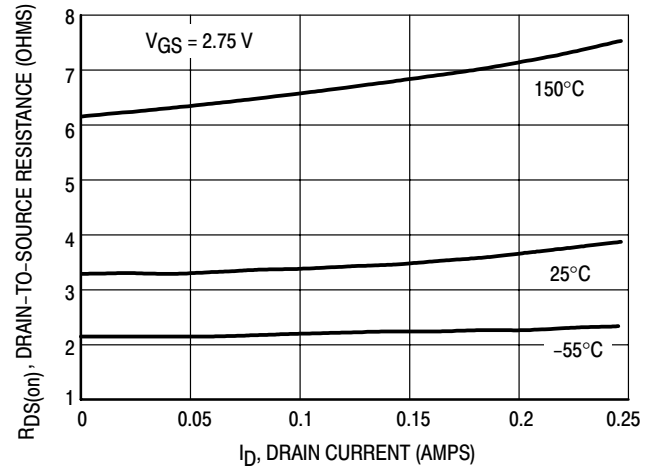

Figure 7. On-Resistance versus Drain Current

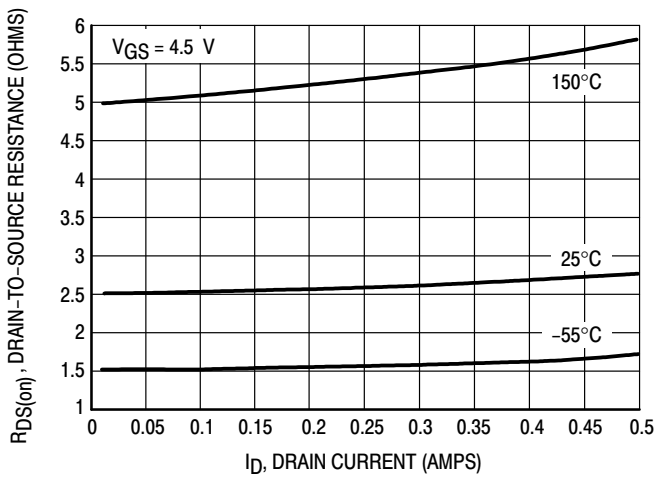

Figure 8. On-Resistance versus Drain Current

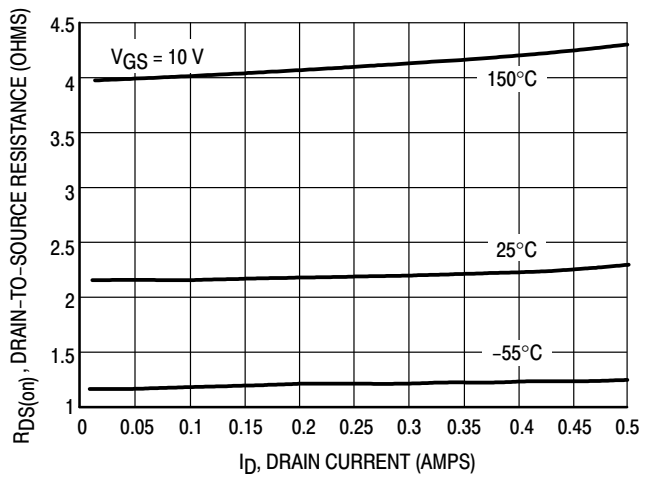

Figure 9. On-Resistance versus Drain Current

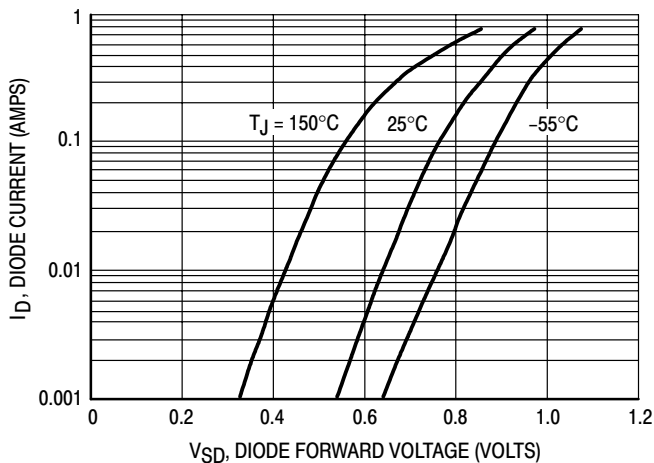

Figure 10. Body Diode Forward Voltage

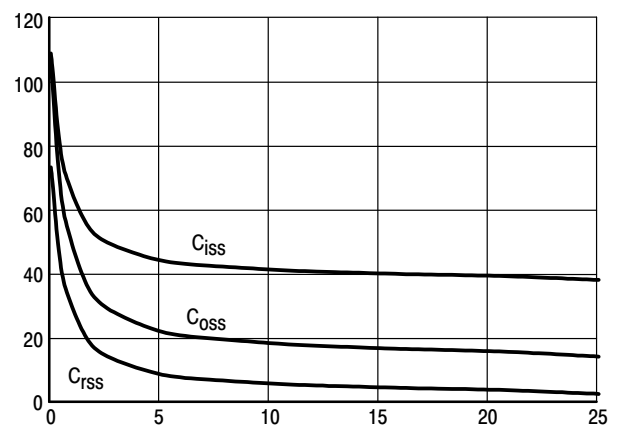
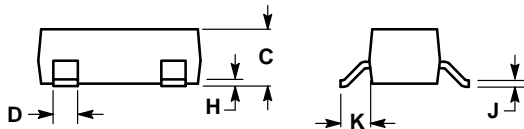
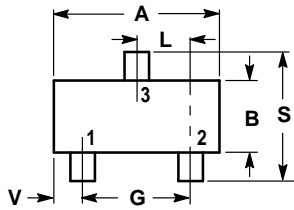

Figure 11. Capacitance

LBSS138LT1G

SOT-23



NOTES:

1. DIMENSIONING AND TOLERANCING PER ANSI Y14.5M, 1982.
2. CONTROLLING DIMENSION: INCH.

DIM	INCHES		MILLIMETERS	
	MIN	MAX	MIN	MAX
A	0.1102	0.1197	2.80	3.04
B	0.0472	0.0551	1.20	1.40
C	0.0350	0.0440	0.89	1.11
D	0.0150	0.0200	0.37	0.50
G	0.0701	0.0807	1.78	2.04
H	0.0005	0.0040	0.013	0.100
J	0.0034	0.0070	0.085	0.177
K	0.0140	0.0285	0.35	0.69
L	0.0350	0.0401	0.89	1.02
S	0.0830	0.1039	2.10	2.64
V	0.0177	0.0236	0.45	0.60

- PIN 1. BASE
 2. EMITTER
 3. COLLECTOR

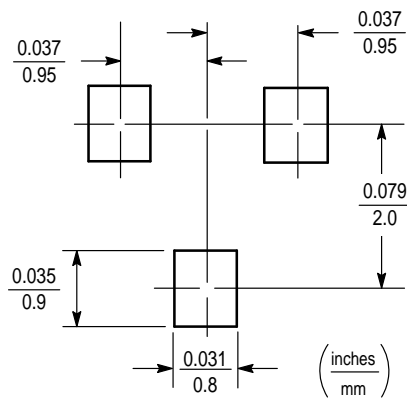

EMBOSSED TAPE AND REEL DATA FOR DISCRETES

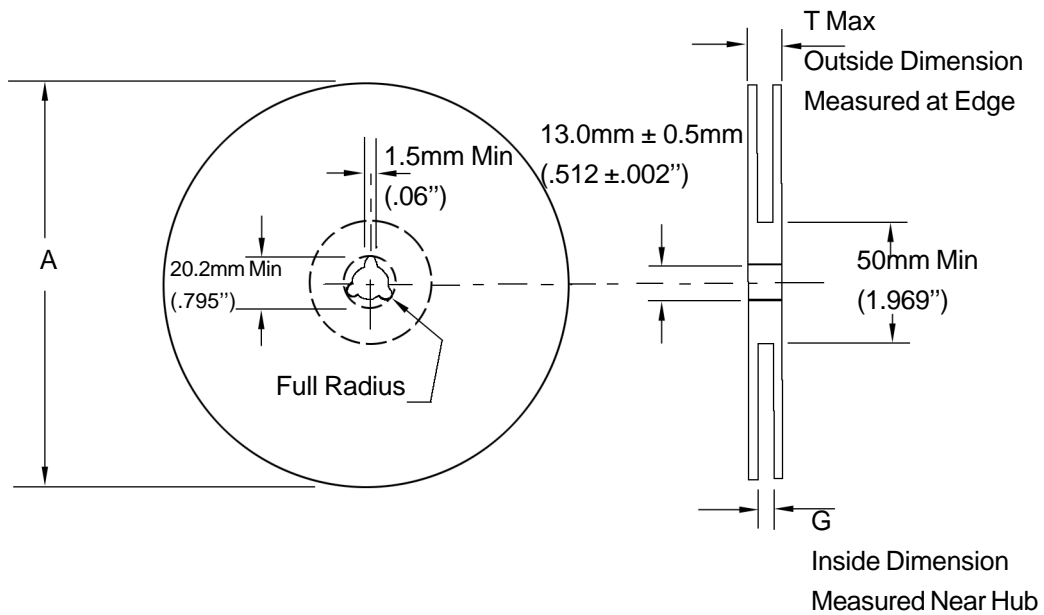

Size	A Max	G	T Max
8 mm	178.0mm (7.0")	8.4mm+1.5mm, -0.0 (.33"+.039", -0.00)	10.9mm (.43")

Reel Dimensions

Metric Dimensions Govern — English are in parentheses for reference only

Storage Conditions

Temperature: 5 to 40 Deg.C (20 to 30 Deg. C is preferred)

Humidity: 30 to 80 RH (40 to 60 is preferred)

Recommended Period: One year after manufacturing

(This recommended period is for the soldering condition only. The characteristics and reliabilities of the products are not restricted to this limitation)

Shipment Specification

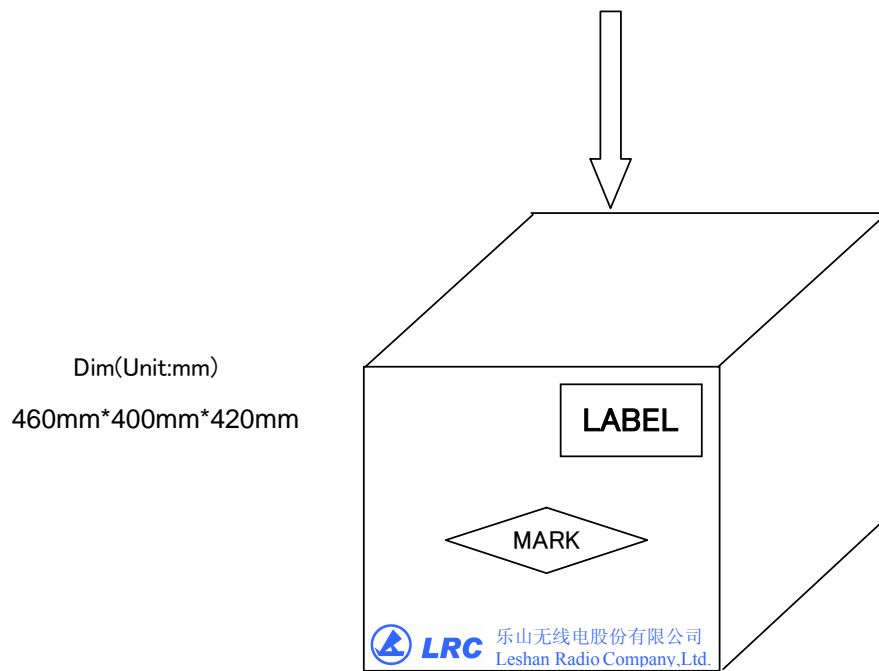
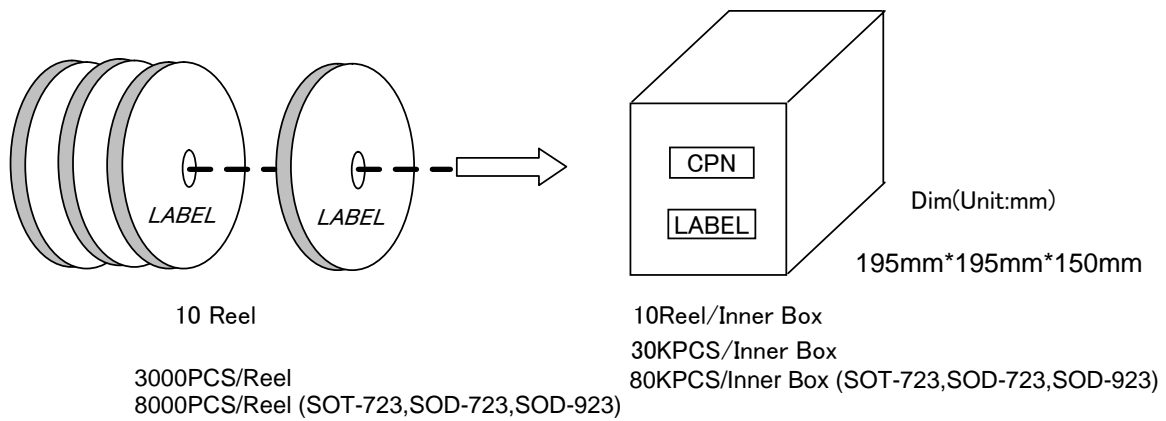

12 Inner Box/Carton

360KPCS/Carton
960KPCS/Carton (SOT-723,SOD-723,SOD-923)